

Innovative Considerate Best for your needs

SR Intelligent Controller



Voice Module



Remote Control Module



Switching Power Supply



MODBUS Module



SR-EHC





Text Panel

Features >>>

- ☞ Real - time clock function
- ☞ Support ARRAY Text Panel
- ☞ Password protection function
- ☞ Removable panel and cost - saving
- ☞ More compact, more powerful, flexible connection/EHC
- ☞ 30 kinds of function blocks, the total amount of function blocks reaches 128
- ☞ I/O can be extended freely. The optimum configuration can be 50DI, 32DO, 8AI
- ☞ Provide 64 Human - Machine Interfaces, and the parameters can be displayed and modified directly
- ☞ UL/CE Approval
- ☞ Support analog input
- ☞ Support MODBUS RTU
- ☞ Wireless remote control function
- ☞ Furnished with simulation software
- ☞ Provide one 1KHz high - speed input port (this type needs to be customized)
- ☞ Telephone remote control, automatic dialing alarm and voice broadcasting function
- ☞ Retain the current data after a power failure and resume operation at the break point (this type needs to be customized)

	SR-12 Main Machine Module			
	Type	Power supply	Input	Output
	SR - 12MRAC	AC110 - 240V	8 points AC digital input	4 points relay output
	SR - 12MRDC	DC12 - 24V	8 points DC digital input 6 points analog	4 points relay output
	SR - 12MTDC	DC12 - 24V	8 points DC digital input 6 points analog	4 points transistor (NPN) output
	SR - 12MGDC	DC12 - 24V	8 points DC digital input 6 points analog	4 points transistor (PNP) output

	SR-22 Main Machine Module			
	Type	Power Supply	Input	Output
	SR - 22MRAC	AC100 - 240V	14 points AC digital input	8 points relay output
	SR - 22MRDC	DC12 - 24V	14 points DC digital input 8 points analog	8 points relay output
	SR - 22MTDC	DC12 - 24V	14 points DC digital input 8 points analog	8 points transistor (NPN) output
	SR - 22MGDC	DC12 - 24V	14 points DC digital input 8 points analog	8 points transistor (NPN) output

	SH series Text Panel			
	Type	Power Supply	Display	Communication port type
	SH300	DC12-24V	4.3"STN(12characters × 4rows)	RS232/RS422/RS485
	SH200	DC12-24V	4.3"STN(12characters × 4rows)	RS232











SR Accessories

	SR-20 Extension Module			
	Type	Power Supply	Input	Output
	SR-20ERA	AC100-240V	12 points AC digital input	8 points relay output
	SR-20ERD	DC12-24V	12 points DC digital input	8 points relay output
	SR-20ETD	DC12-24V	12 points DC digital input	8 points transistor (NPN) output
	SR-20EGD	DC12-24V	12 points DC digital input	8 points transistor (PNP) output

	Telephone Voice Module		
	Type	Power Supply	Property
	SR-VPA	AC100-240V	Dial alarm call automatically, telephone remote control and voice broadcast.
	SR-VPD	DC12-24V	

Remote Control Module			
Type	Power supply	Property	
SR-RCA	AC110/220V	Remote receiver module provides 6 remote control input points.	
SR-RCD	DC12-24V		
SR-TC	DC3V(Two AA batterie)	Remote Transmitter	
SR-EANT		SR-RCA/RCD lengthened connecting antenna.	

Modbus Module	
Type	Property
SR-MC	Support several kinds of communication port, including RS232 and RS485; the communication between SR PLC and human-machine interface through MODBUS RTU protocol can be implemented; max.256 SR PLCs interconnected can be supported.

	SH-EHC Connection set of SR-HMI Remotely connect SR main machine with SR-HMI		SR-CP side-plug type/ SR-DCP direct-plug type The communication cable between SR and PC
	SR-HMI/SR-WRT SR-HMI: Monitoring panel SR-WRT: Programming panel		SR_DUSB The communication cable between SR and PC USB
	SR-TP The communication cable between SH-300 and SR		SR-AUD The recording microphone and wire between the PC sound card and SR-VPA/D
	Switching Power Supply Supplies DC5V, 12V, 24V, and 48V		SR-LED to display the running status of power, CPU, and program
	SR-ECBD/A Lengthened connecting bridge of AC/DC type, to remotely connect the machine and extension module		AF(SR)-USB The DIN-rail transform interface between USB and RS232

The Construction and installation of SR

12 points Basic Module >>>

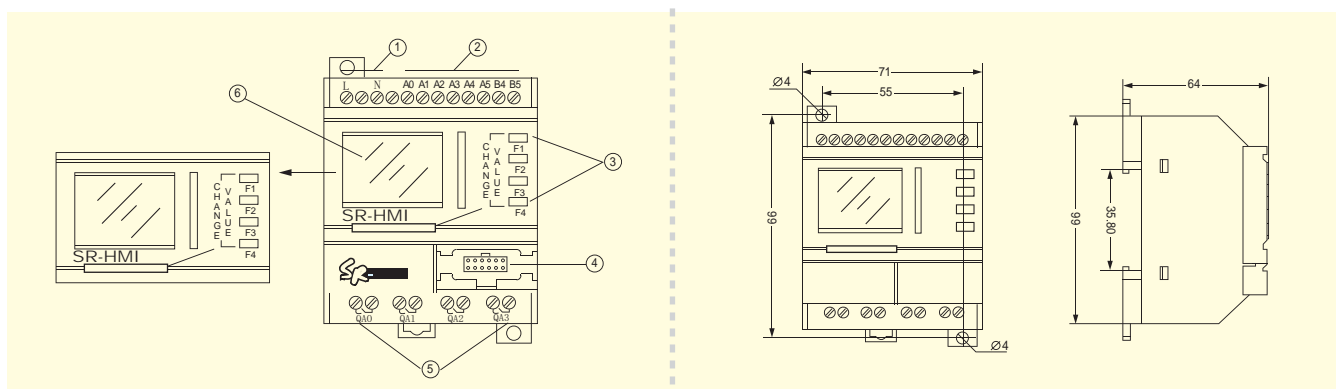

- ① Power supply
- ② Input terminal
- ③ Small human - machine interface (SR - HMI) or programming panel (SR - WRT)
- ④ Communication interface
- ⑤ Output terminal (relay type or transistor type)
- ⑥ LCD display

22 points Basic Module >>>

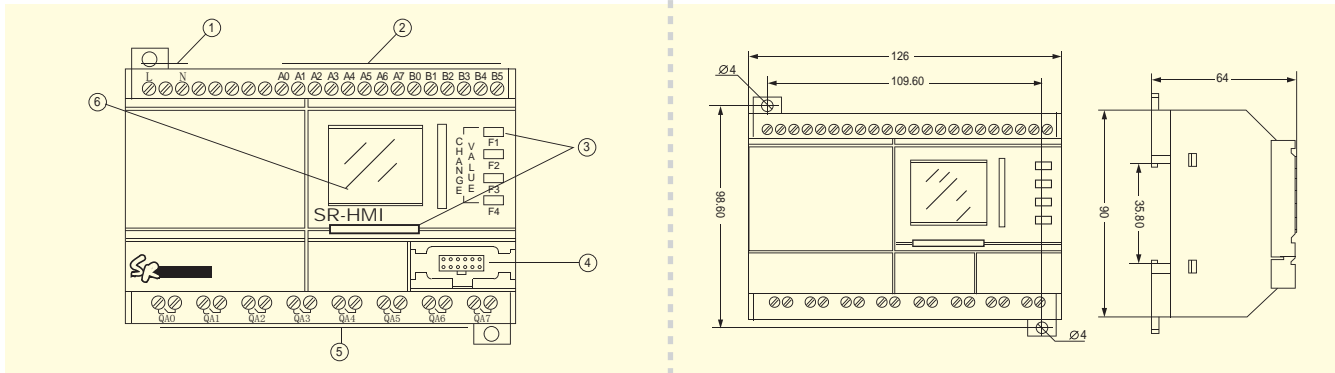

- ① Power supply (AC 100V - 240V, or DC12V - 24V)
- ② Input terminal
- ③ Small human - machine interface (SR - HMI) or programming panel (SR - WRT)
- ④ Communication interface
- ⑤ Output terminal (relay type or transistor type)
- ⑥ LCD display

20 points Extension Module >>>

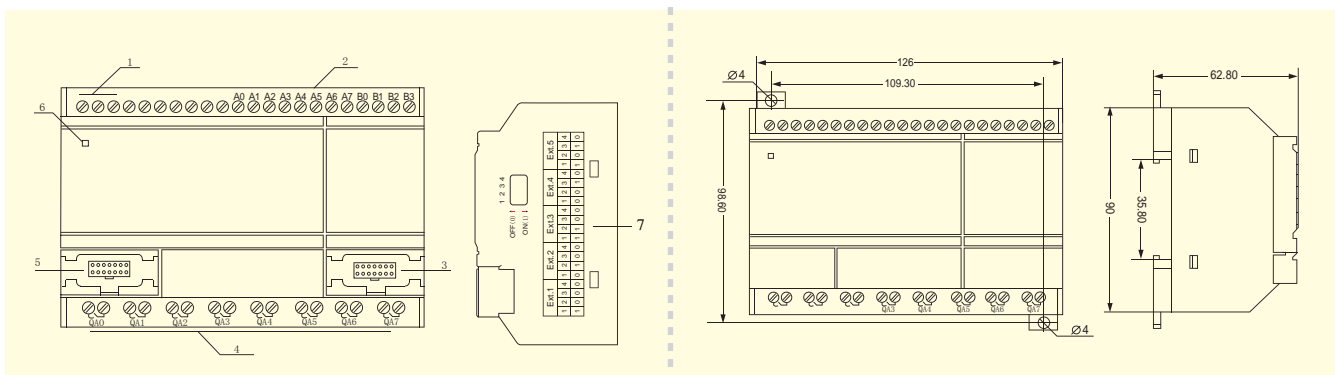

- ① Power supply
- ② Input terminal
- ③ The interface of connecting with subordinate machine (communication/extension/voice/remote control)
- ④ Output terminal
- ⑤ The interface of connecting with host machine (communication/extension/voice/remote control)
- ⑥ Power indicator
- ⑦ Set the address of the extension module

Remote Control Module >>>

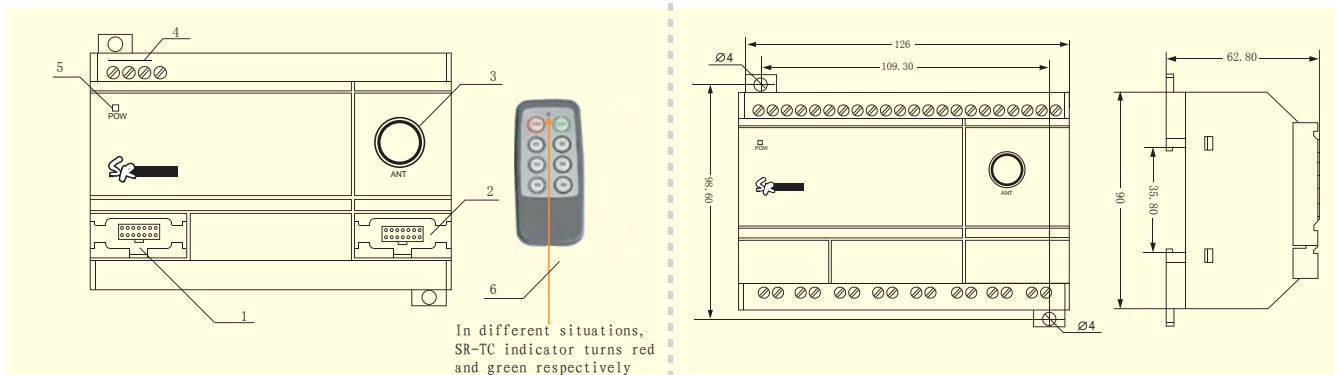

- ① The interface of connecting with host machine (main machine/voice/extension)
- ② The interface of communicating with PC or next subordinate machine
- ③ The antenna of remote receiver
- ④ Power supply of remote control module (AC 110V/AC 220V, or DC12V - 24V)
- ⑤ Power indicator
- ⑥ SR - TC transmitter

Telephone Voice Module >>>

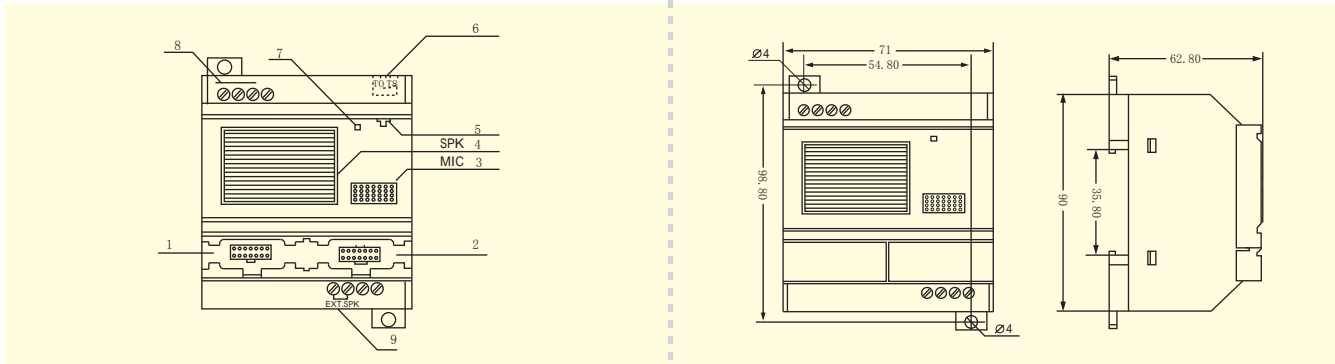

- ① The interface of connecting the voice module with SR host machine extension and remote control
- ② The interface of connecting the voice module with communication cable
- ③ MIC (It can be used for off-line recording or recording from the panel of the main machine.)
- ④ SPK (Broadcasting interface of speaker internally installed in the voice module)
- ⑤ Audio input port for on-line recording of the voice module (it is connected with the audio output port of PC.)
- ⑥ Socket of telephone crystal plug (connects to telephone wire directly)
- ⑦ Indicator of the power and recording of the voice module (It will be green when the voice module is powered; it will be red when the voice module starts recording. The users have to start recording after the indicator is on, and stop recording when the indicator is off, or the voice can not be recorded.)
- ⑧ Power supply (AC 100V -240V, or DC12V - 24V)
- ⑨ The Audio output port (to connect with user's active speaker)

Text Panel Module >>>

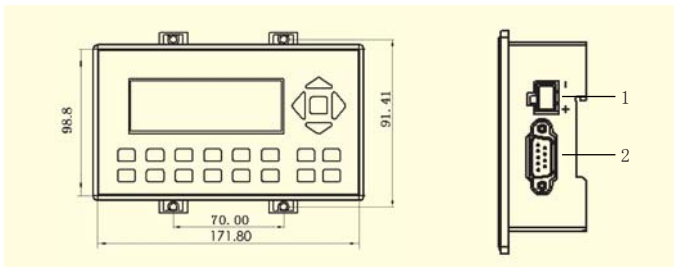

- ① Power supply DC12V - 24V
- ② Communication port: RS232/422/485

SH-300 has more wider display than HMI of SR, Connect the communication port on the right of SH-300 with the communication port of SR PLC through the supplied SR communication cable. Installation dimensions: 165mm*85mm

Remark: The above products adopt 35mm DIN-rail installation

Hardware Connections

Connect to the power supply >>>

AC power supply

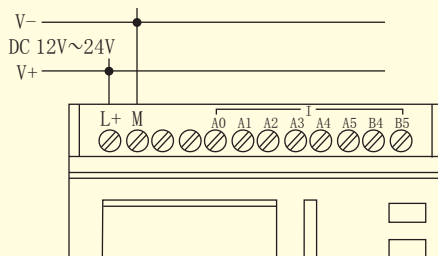

DC power supply

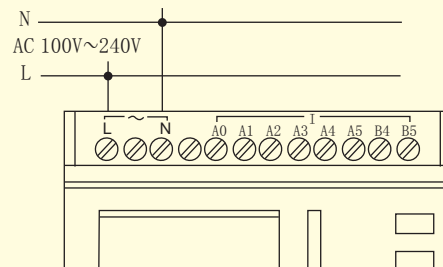

Input Connections >>>

Digital input connections (AC type)

AC type

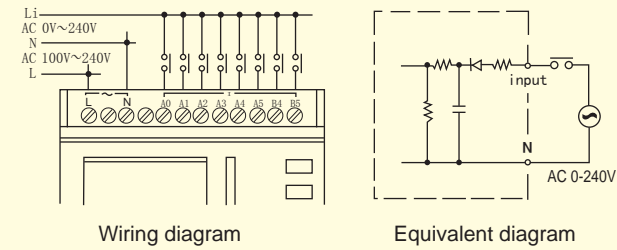

DC type

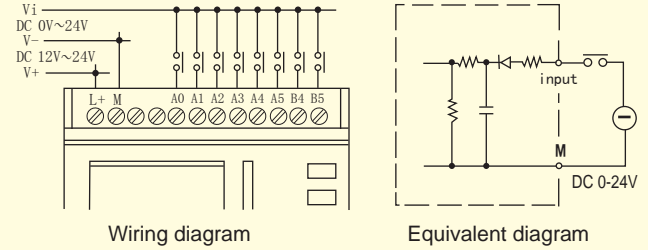

Analog input connections (Only for DC type, and the analog signal is DC0-10V. The minimum accuracy: 0.1)

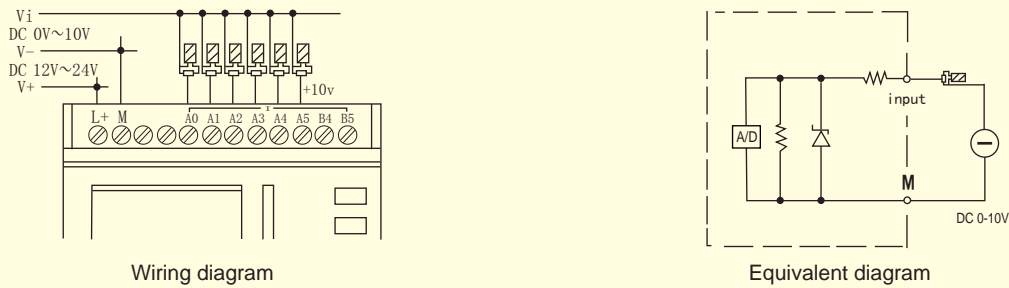

Output Connections >>>

Relay output connections

Various loads such as lamp, fluorescent tube, contactor etc., can be connected to the outputs of SR. The maximum supplied output current is: the resistive load: 10A, the inductive load: 2A.

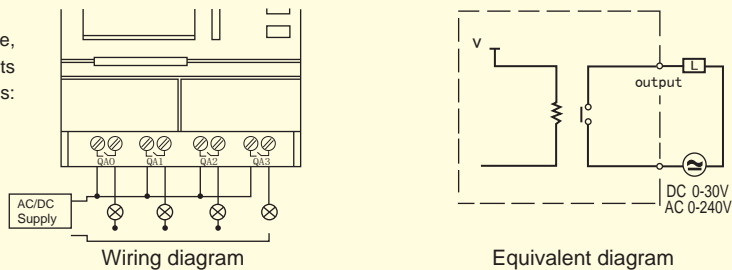

Transistor output connections

The transistor load connected with SR must have the following property:
The maximum switching current should not exceed 2A;
The transistor load includes two types: NPN and PNP.

PNP type transistor output

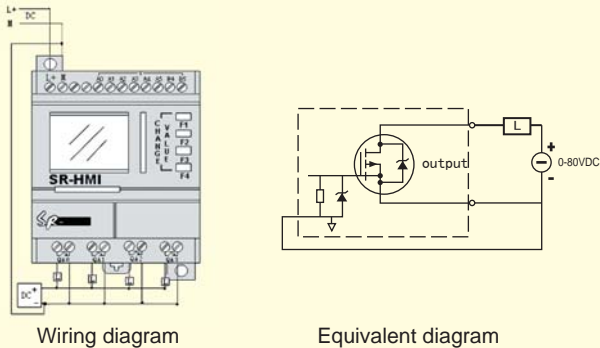

The DC negative pole " - " of the load should be connected to " M " of SR power supply, and the load must be connected to the positive pole " + " of DC power supply
The voltage of the load should not be more than DC80V

PNP type transistor output

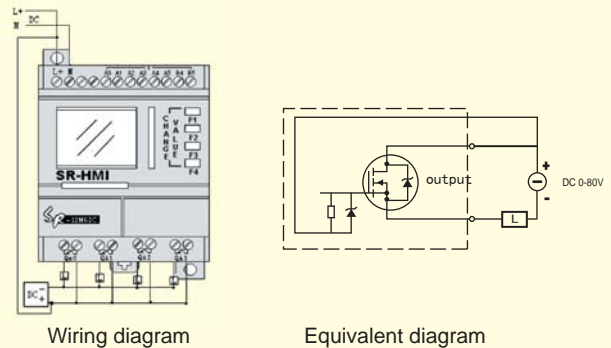

The DC positive pole " + " of the load should be connected to " L+ " of SR power supply, and the load must be connected to the negative pole " - " of DC power supply.
The voltage of the load should not be more than DC80V

SR Software and Function

The simple Super CAD software provides a user-friendly operation interface. It can easily edit function diagram through choosing and pulling relevant function and connection, and can transform and examine the program on PC through the off-line simulation function.

There are 8 basic function blocks, 14 special function blocks, 8 I/O points and voice function blocks. Every function block can implements the specific control function independently. When several function blocks are linked together in a specific way, the complicated program can be created quickly and easily. At present, many application examples have been provided on ARRAY website.



8 Basic Functions

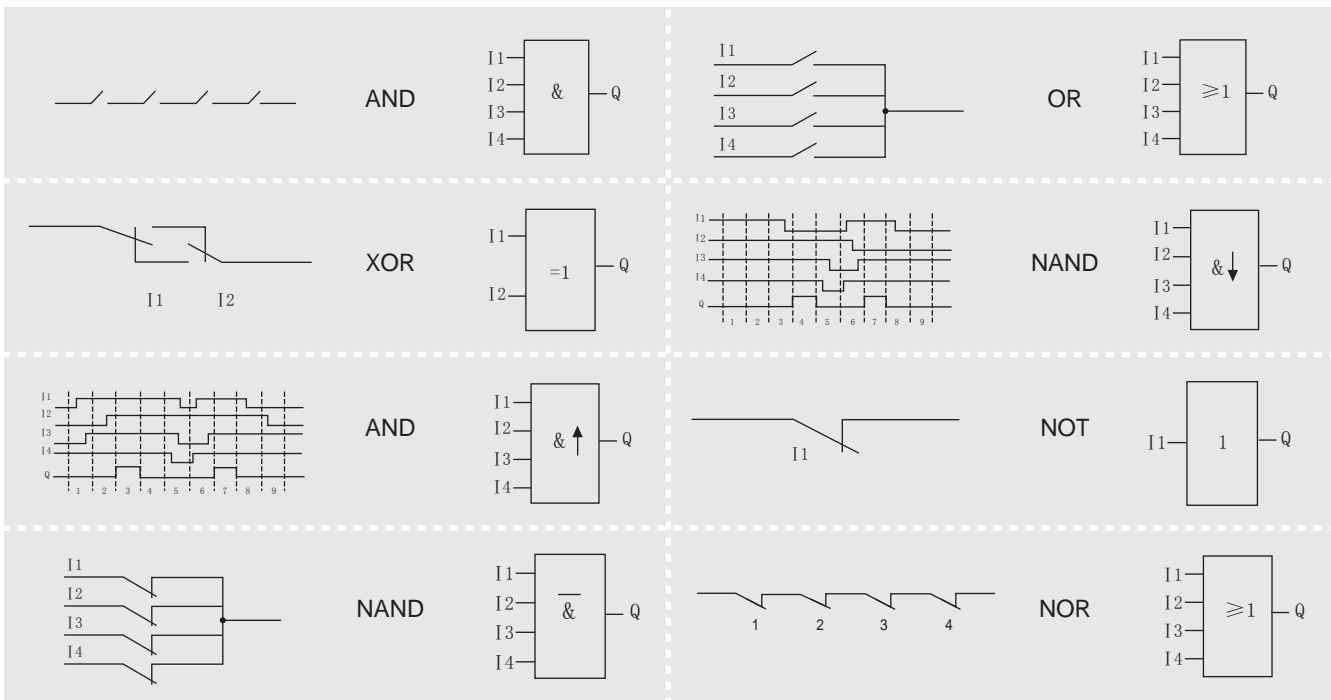

8 I/O Functions

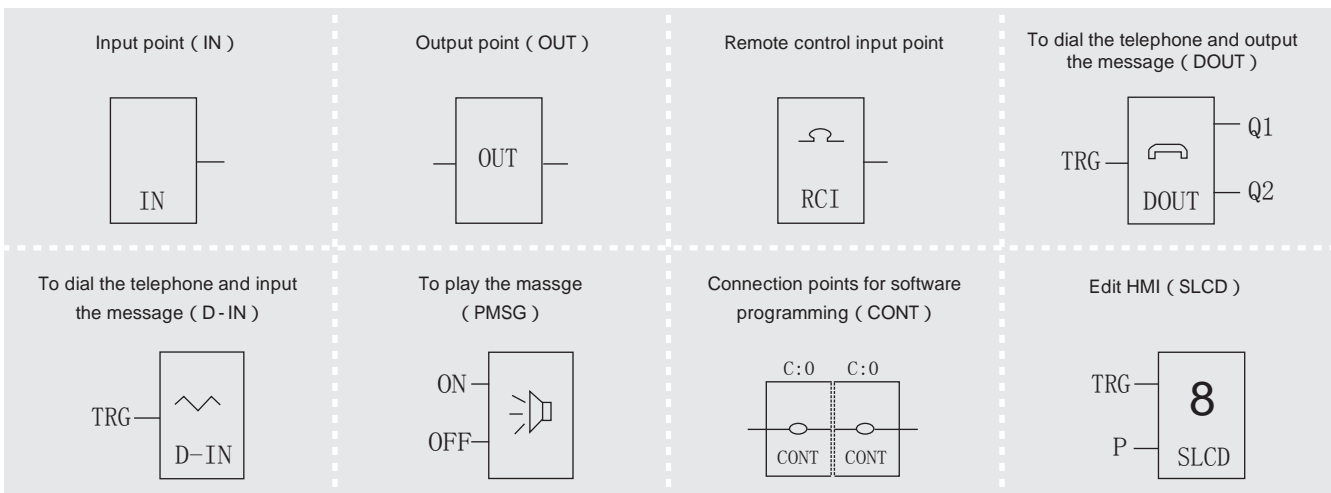

14 Special Functions >>>

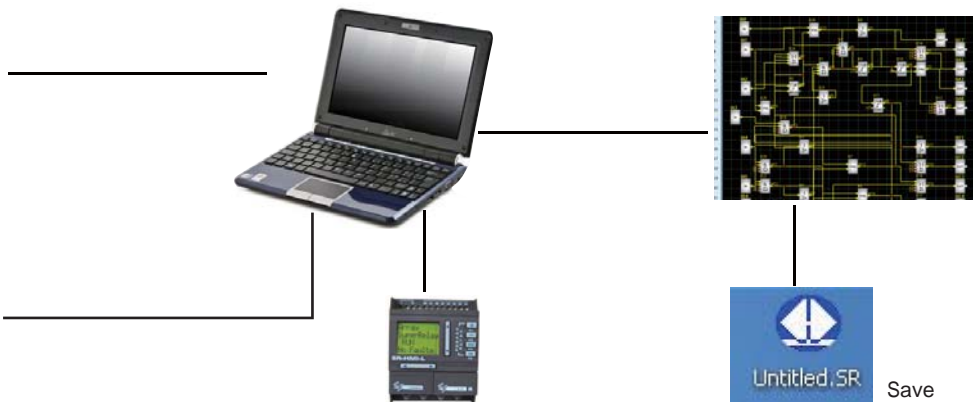
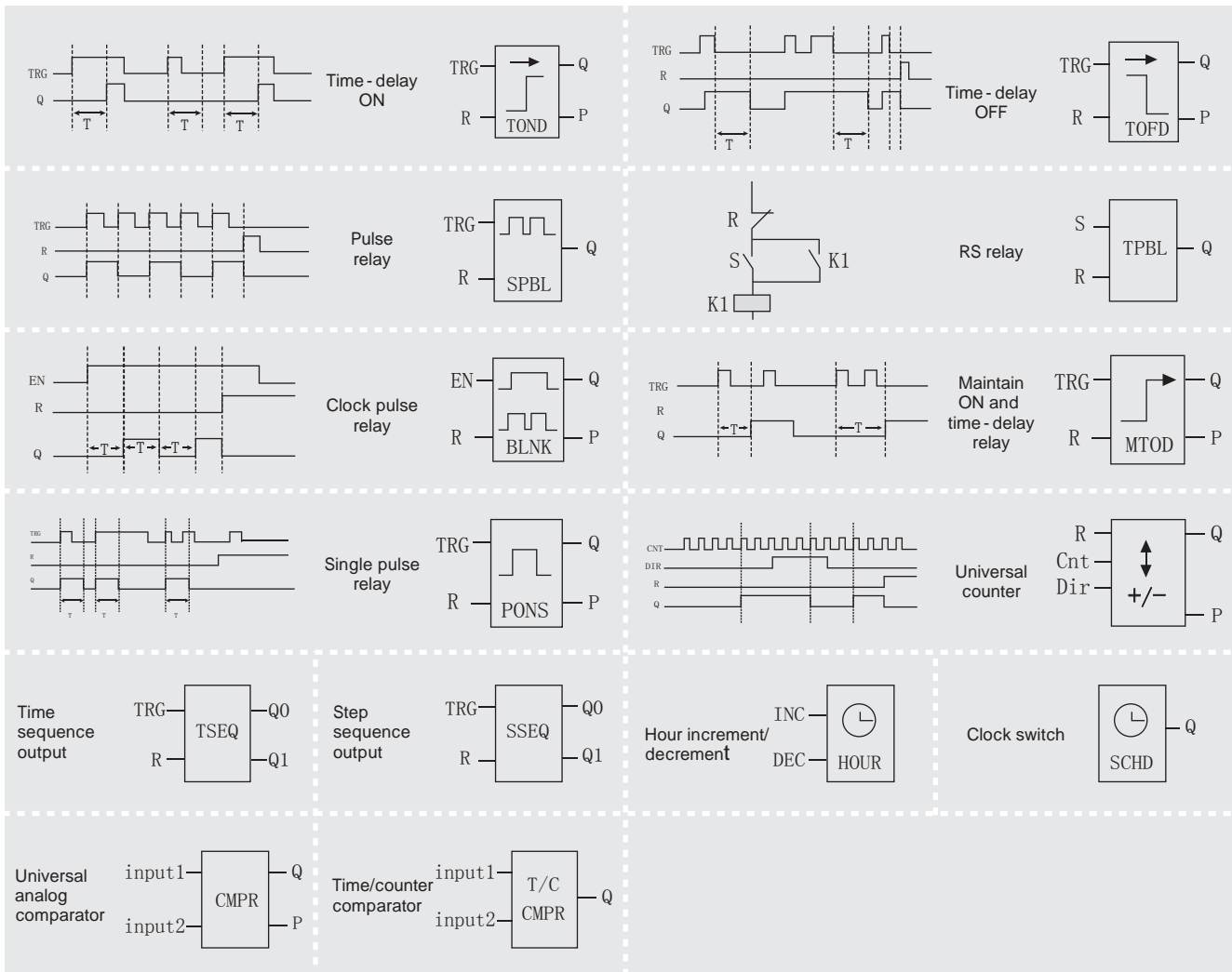

Create the program Software simulation Online testing Save the file

Uses SR program software Super CAD >>>>

- Simulates the whole process through the whole function of SR
- Simulates the analog signal through the AB value
- Simulates the clock date
- Shows the current value and set value through SR display
- Shows the status of parameter value and current value through SR display
- Switch the ON/OFF line status of SR PLC and software Super CAD under the RUN/STOP mode

SR Software and Function

Function block and the number of function block >>>>

Function block

SR function block refers to the function that can convert a message to the output message. When creating program, several function blocks should be chosen, and linked through connecting line according to the logical relation.

When creating program, several function blocks needs to be linked. Click  on the tool bar.

Basic function block, i.e.: AND

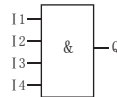

In the left figure, I1, I2, I3, I4 are all connected to the AND function block, which means four input points must be 1, then output will be 1, or the output will be 0. If the user only needs I1 and I3, click twice to enter into the setting of property box.

The view of function block on SR display

Provides 64 human-machine interfaces

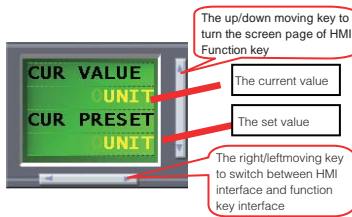

The view of alarm triggering function
All function blocks with output can trigger the HMI

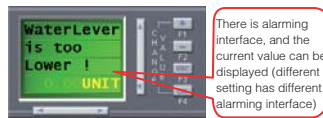

Provides 32 function keys:

The function key has the same capabilities as soft switch, just like In. On LCD, all defined function keys can be displayed with explanation of each function key. In Super CAD 8 pages of function keys are provided and each page contains 4 function keys.

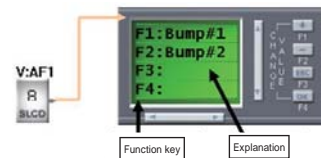

The number of function blocks

Every function block in SuperCAD is allocated a number, which indicates the internal connections among function blocks. Those numbers are mainly easy for viewing the program. As following simple example shows, B2 is connected to the reset terminal of B0, B1 is connected to the triggering terminal, and B0 is connected to the output terminal of QA0.

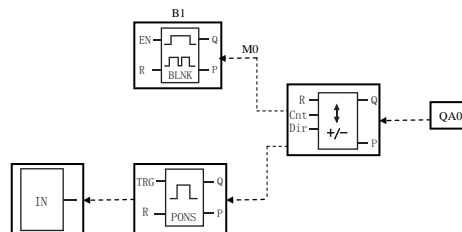
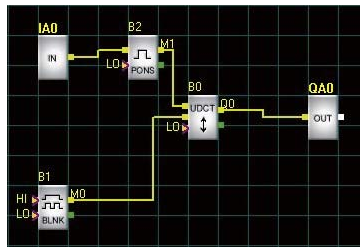

The program diagram on the SR-WRT programming panel is shown above. The function blocks are linked together through numbers. The function block can be viewed, modified and deleted through programming panel.

SR: Entering into SR easily

Circuit diagram Although you have known the express method of logic in circuit diagram, the example of the conventional solution is given again.

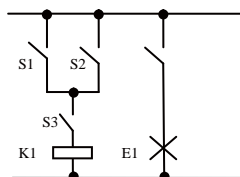

Through switches (S1 or S2) and S3 to turn ON/OFF the load E1.
When S1 or S2 is closed, close the S3 will make relay K1 actuated.

Using SR to create program Save Cost and Increase Efficiency

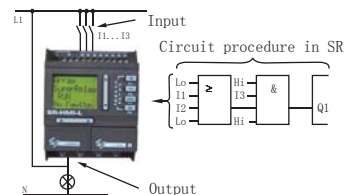

Common Parameters >>>

Parameter \ Type	SR-12MRAC SR-22MRAC SR-20ERA	SR-12MRDC SR-22MRDC SR-20ERD	SR-12MTDC SR-22MTDC SR-20ETD	SR-12MGDC SR-22MGDC SR-20EGD
Rated voltage	AC100-240V	DC12-24V	DC12-24V	DC12-24V
Permitted voltage range	AC85-260V	DC10-28V	DC10-28V	DC10-28V
Digital input	8(A0~A5, B4~B5)/ 14(A0~A5, B0~B5)/ 12(X0~X7, Y0~Y3)	8(A0~A5, B4~B5)/ 14(A0~A7, B0~B5)/ 12(X0~X7, Y0~Y3)	8(A0~A5, B4~B5)/ 14(A0~A7, B0~B5)/ 12(X0~X7, Y0~Y3)	8(A0~A5, B4~B5)/ 14(A0~A7, B0~B5)/ 12(X0~X7, Y0~Y3)
Analog input	No	6(A0~A5) / 8(A0~A7)/ No	6(A0~A5) / 8(A0~A7)/ No	6(A0~A5) / 8(A0~A7)/ No
Voltage of signal 0	AC0-40V	DC0-5V	DC0-5V	DC0-5V
Voltage of signal 1	AC85-240V	DC10-24V	DC10-24V	DC10-24V
Analog voltage	No	DC0-10V/ DC0-10V/ No	DC0-10V/ DC0-10V/ No	DC0-10V/ DC0-10V/ No
Delay time from 0 to 1	50ms	50ms	50ms	50ms
Delay time from 1 to 0	50ms	50ms	50ms	50ms
Output				
Output type	Relay	Relay	Transistor (NPN)	Transistor (NPN)
Output current	Resistive load10A Inductive load 2A	Resistive load10A Inductive load 2A	≤2A	≤2A
ON/OFF Frequency				
Mechanical frequency	10Hz			
Resistive load/lamp load	2Hz			
Inductive load	0.5Hz			
Environmental parameter				
Working temperature	0°C-55°C			
Storing temperature	-40°C-70°C			
Store/transport	-40°C-70°C			
Protection type	IP20			
Anti-interference	EN55011(B class)			
Insulation strength	IEC1131			
Others				
25°C clock buffer	80h			
Real-time clock precision	Max ± 5s/day			
Protection grade	IP20			
Anti-interference	In accordance with EN55011 (grade B)			
Permitted main frequency	47-63Hz			
Quantity of function blocks	128个			
Storage capacity	64K			
Installation method	Standard 35mm DIN rail mounting or screw mounting			

SR Technical Parameters

Telephone Voice Module

Telephone voice module	
Item	Standard
Receive signal automatically	CCITT-DTMF
Dialing automatically	CCITT-DTMF
Record message	100 messages in total (8 minutes in total, no more than 15 seconds for each section)

Remote Control Module

Remote receiver module	
Item	Parameters
Power consumption	1.5W
Working frequency	VHF (310 ~ 340MHz) UHF (415 ~ 460MHz)
Control distance	≤70m
Remote control transmitter	
Power cost	40mW
Frequency	VHF (310 ~ 340MHz) UHF (415 ~ 460MHz)
king voltage	DC 3V (two AA batteries)

Text Panel

Text panel	
Display	4.3" STN LCD
Resolution	192 × 64pixels
LCM lifetime	25 ± 2°C, 65 ± 10% Under RH circumstance, above 50000 hours
Illumination	60 cd/m ²
Contrast	Potentiometer adjustment
Memory	110KB Flash ROM
Communication port	PC RS232& PLC RS485/422 & PLC RS232
Function key	14 definable function keys
Allowable power disruption	Within 20ms
Outline dimension	171.8 × 98.8 × 38.6mm
Display dimension	96 × 32mm
Installation note dimension	165 × 85mm
Cooling method	Natural air cooling
Weight	260g
Power supply	12 ~ 24VDC ± 10% <300mA
Withstanding voltage test	500VAC 1 minute (between signal and earth)
Insulation resistance	Beyond 10MΩ @ DC500V(between signal and earth)
Working temperature	-10°C ~ 60°C
Working humidity	20 ~ 90%RH(without condensation)
Storage temperature	-20°C ~ 70°C
Anti-interference test	Voltage 1500Vp-p, impulse period 1us, lasting 1s
Vibration resistance	10~25Hz (X, Y, Z direction, 2G, 30 minutes)
Protection grade	IP65 (front panel)